

Rechnungsanschrift:

Versandadresse:

 siehe Rechnungsanschrift

 Bestellung
 Kostenvoranschlag

Kunden-Nr.: _____

Besteller: _____

Datum: _____

Unterschrift: _____

Kommission: _____

Bob – Toilettensitzsystem



- Toilettensitzsystem aus pflegeleichtem Kunststoff mit vielfachen Auswahlmöglichkeiten
- als Aufsatz auf der Toilette, mit Untergestell freistehend oder als Duschstuhl verwendbar
- geringes Gewicht



HMV-Nr.: 33.40.01.4004 (für den Sitz, Rücken und Fußbank)



HMV-Nr.: 33.40.04.2003 (für den Sitz, Rücken, fahrbarem Untergestell und Fußbank)

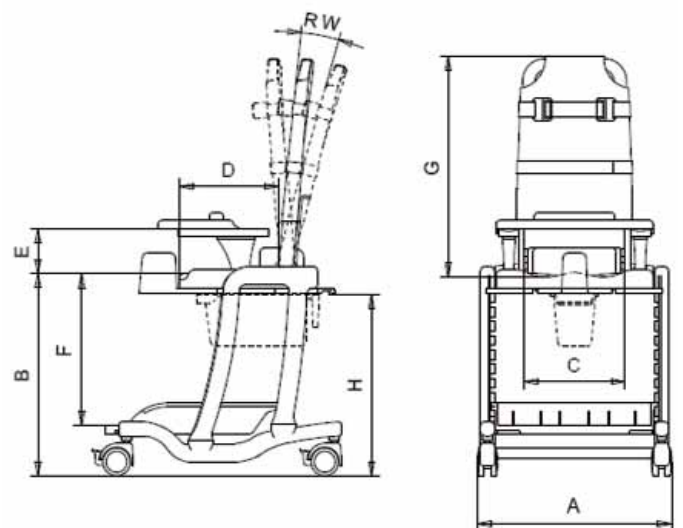

HMV-Nr.: 33.40.04.2004 (für den kompletten Toilettensstuhl)





Maße - Grundmodell			
		Bob Gr. 1	Bob Gr. 2
A	Breite Untergestell	52 cm	52 cm
B	Sitzhöhe	18 - 51 cm	18 - 51 cm
C	Sitzbreite	30 cm	41 cm
D	Sitztiefe	23 / 28 cm	29 / 35 cm
E	Höhe Sitz bis Armlehne	14 cm	18 cm
F	Unterschenkellänge Toilettensstuhl	12 - 42 cm	12 - 42 cm
F	Unterschenkellänge Toilettensitz	20 - 30 cm	28 - 38 cm
G	Rückenhöhe	61 cm	-
G	kurzer Rücken	-	46 cm
G	langer Rücken	-	86 cm
H	Überfahrbare Beckenhöhe	48 cm	48 cm
RW	Rückenwinkel	85° / 95° / 105°	85° / 95° / 105°
	Körpergröße	76 - 127 cm	122 - 183 cm
	max. Belastung	82 kg	82 kg

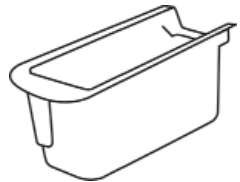
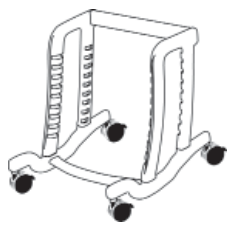

Sitz														
Bob Toilettensitz Gr. 1 – inkl. Sitz, weicher Sitzauflage mit integriertem Spritzschutz, Armlehnen und Beckengurt mit Schloss 	Bob Toilettensitz Gr. 2 – inkl. Sitz, weicher Sitzauflage, Armlehnen und Beckengurt mit Schloss 	Anbaubügel – zur Montage der nebenstehenden Sitze auf einer Toilette 												
<table border="1"> <tr><td>Sitztiefe</td><td>23 / 28 cm</td></tr> <tr><td>Sitzbreite</td><td>30 cm</td></tr> <tr><td>max. Belastung</td><td>82 kg</td></tr> </table>	Sitztiefe	23 / 28 cm	Sitzbreite	30 cm	max. Belastung	82 kg	<table border="1"> <tr><td>Sitztiefe</td><td>29 / 35 cm</td></tr> <tr><td>Sitzbreite</td><td>41 cm</td></tr> <tr><td>max. Belastung</td><td>82 kg</td></tr> </table>	Sitztiefe	29 / 35 cm	Sitzbreite	41 cm	max. Belastung	82 kg	(ACHTUNG: nicht im Grundmodell enthalten)
Sitztiefe	23 / 28 cm													
Sitzbreite	30 cm													
max. Belastung	82 kg													
Sitztiefe	29 / 35 cm													
Sitzbreite	41 cm													
max. Belastung	82 kg													
<table border="1"> <tr><th colspan="2">Preis / Stück</th></tr> <tr><td><input type="checkbox"/> 5301000</td><td>490,00 €</td></tr> </table>	Preis / Stück		<input type="checkbox"/> 5301000	490,00 €	<table border="1"> <tr><th colspan="2">Preis / Stück</th></tr> <tr><td><input type="checkbox"/> 5302000</td><td>598,00 €</td></tr> </table>	Preis / Stück		<input type="checkbox"/> 5302000	598,00 €	<table border="1"> <tr><th colspan="2">Preis / Stück</th></tr> <tr><td><input type="checkbox"/> 5300004</td><td>59,00 €</td></tr> </table>	Preis / Stück		<input type="checkbox"/> 5300004	59,00 €
Preis / Stück														
<input type="checkbox"/> 5301000	490,00 €													
Preis / Stück														
<input type="checkbox"/> 5302000	598,00 €													
Preis / Stück														
<input type="checkbox"/> 5300004	59,00 €													

Rücken														
Rücken für Toilettensitz Gr. 1 – inkl. Brustgurt und Kopfstütze 	Kurzer Rücken für Toilettensitz Gr. 2 inkl. Brustgurt 	Langer Rücken für Toilettensitz Gr. 2 inkl. Kopfstütze und 2 Brustgurte 												
<table border="1"> <tr><td>Rückenhöhe</td><td>61 cm</td></tr> </table>	Rückenhöhe	61 cm	<table border="1"> <tr><td>Rückenhöhe</td><td>46 cm</td></tr> </table>	Rückenhöhe	46 cm	<table border="1"> <tr><td>Rückenhöhe</td><td>86 cm</td></tr> </table>	Rückenhöhe	86 cm						
Rückenhöhe	61 cm													
Rückenhöhe	46 cm													
Rückenhöhe	86 cm													
<table border="1"> <tr><th colspan="2">Preis / Stück</th></tr> <tr><td><input type="checkbox"/> 5301008</td><td>350,00 €</td></tr> </table>	Preis / Stück		<input type="checkbox"/> 5301008	350,00 €	<table border="1"> <tr><th colspan="2">Preis / Stück</th></tr> <tr><td><input type="checkbox"/> 5302008</td><td>320,00 €</td></tr> </table>	Preis / Stück		<input type="checkbox"/> 5302008	320,00 €	<table border="1"> <tr><th colspan="2">Preis / Stück</th></tr> <tr><td><input type="checkbox"/> 5302009</td><td>480,00 €</td></tr> </table>	Preis / Stück		<input type="checkbox"/> 5302009	480,00 €
Preis / Stück														
<input type="checkbox"/> 5301008	350,00 €													
Preis / Stück														
<input type="checkbox"/> 5302008	320,00 €													
Preis / Stück														
<input type="checkbox"/> 5302009	480,00 €													

Zubehör																
Tisch für Toilettensitz 	Abduktionskeil – Höhe 6 cm 	Spritzschutz – für die weiche Sitzauflage Gr. 2 														
<table border="1"> <tr><th colspan="2">Preis / Stück</th></tr> <tr><td><input type="checkbox"/> für Gr. 1 (5301007)</td><td>245,00 €</td></tr> <tr><td><input type="checkbox"/> für Gr. 2 (5302007)</td><td>280,00 €</td></tr> </table>	Preis / Stück		<input type="checkbox"/> für Gr. 1 (5301007)	245,00 €	<input type="checkbox"/> für Gr. 2 (5302007)	280,00 €	<table border="1"> <tr><th colspan="2">Preis / Stück</th></tr> <tr><td><input type="checkbox"/> 5300001</td><td>98,00 €</td></tr> </table>	Preis / Stück		<input type="checkbox"/> 5300001	98,00 €	<table border="1"> <tr><th colspan="2">Preis / Stück</th></tr> <tr><td><input type="checkbox"/> 5302016</td><td>52,00 €</td></tr> </table>	Preis / Stück		<input type="checkbox"/> 5302016	52,00 €
Preis / Stück																
<input type="checkbox"/> für Gr. 1 (5301007)	245,00 €															
<input type="checkbox"/> für Gr. 2 (5302007)	280,00 €															
Preis / Stück																
<input type="checkbox"/> 5300001	98,00 €															
Preis / Stück																
<input type="checkbox"/> 5302016	52,00 €															

Untergestell / Fußbank																					
Toiletteneimer 	fahrbares Untergestell 	Fußbank – für das nebenstehende fahrbare Untergestell 	Fußbank für den Toilettensitz (nicht in Verbindung mit obenstehendem Abduktionskeil nutzbar) 																		
<table border="1"> <tr><th colspan="2">Preis / Stück</th></tr> <tr><td><input type="checkbox"/> 5300105</td><td>59,00 €</td></tr> </table>	Preis / Stück		<input type="checkbox"/> 5300105	59,00 €	<table border="1"> <tr><th colspan="2">Preis / Stück</th></tr> <tr><td><input type="checkbox"/> 5300005</td><td>750,00 €</td></tr> </table>	Preis / Stück		<input type="checkbox"/> 5300005	750,00 €	<table border="1"> <tr><th colspan="2">Preis / Stück</th></tr> <tr><td><input type="checkbox"/> 5300003</td><td>195,00 €</td></tr> </table>	Preis / Stück		<input type="checkbox"/> 5300003	195,00 €	<table border="1"> <tr><th colspan="2">Preis / Stück</th></tr> <tr><td><input type="checkbox"/> Gr. 1 (5300102)</td><td>195,00 €</td></tr> <tr><td><input type="checkbox"/> Gr. 2 (5300202)</td><td>195,00 €</td></tr> </table>	Preis / Stück		<input type="checkbox"/> Gr. 1 (5300102)	195,00 €	<input type="checkbox"/> Gr. 2 (5300202)	195,00 €
Preis / Stück																					
<input type="checkbox"/> 5300105	59,00 €																				
Preis / Stück																					
<input type="checkbox"/> 5300005	750,00 €																				
Preis / Stück																					
<input type="checkbox"/> 5300003	195,00 €																				
Preis / Stück																					
<input type="checkbox"/> Gr. 1 (5300102)	195,00 €																				
<input type="checkbox"/> Gr. 2 (5300202)	195,00 €																				